

0.3 mm Contact Pitch, 0.9 mm above the board, Flexible Printed Circuit ZIF Connectors.

FH 25 Series

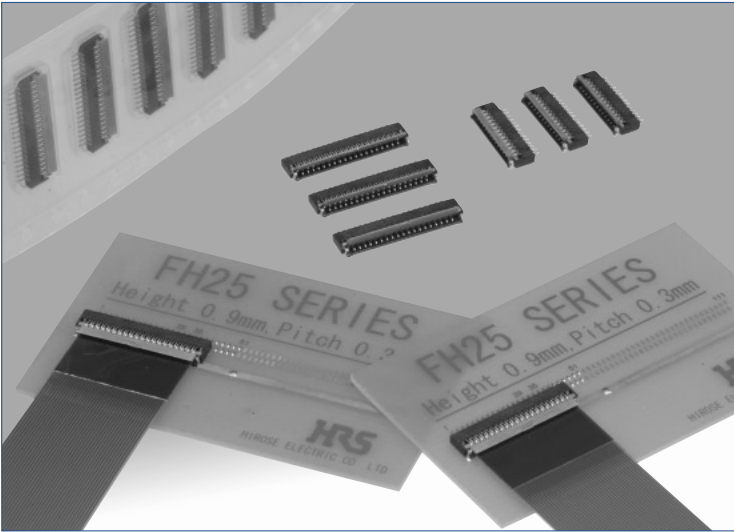

■ Features

1. Extremely light weight

The largest version, with all contacts loaded, weights only 0.11grams.

2. Conductive traces on the PCB can run under the connector

No exposed contacts on the bottom of the connector.

3. High density together with reliable solderability on the board

Staggered contact points and the leads plus the nickel barriers assure sufficient distance to prevents solder bridging.

4. Easy FPC insertion and reliable electrical connection

Proven Flip Lock® actuator allows easy insertion of FPC. Tactile sensation when fully closed confirms complete electrical and mechanical connection.

5. Accepts standard thickness FPC

0.2 mm thick standard Flexible Printed Circuit board can be used. This is the only ultra-low profile ZIF connector allowing the use of standard FPC.

6. Board placement with automatic equipment

Flat top surface and packaging on the tape-and-reel allows use of vacuum nozzles.
Standard reel contains 5,000 connectors.

■ Applications

Mobile phones, PDA's, digital cameras, digital video cameras, LCD connections, plasma displays (PDP), camera modules and other compact devices requiring Flexible Printed Circuit connections using high reliability ultra-small profile connectors.

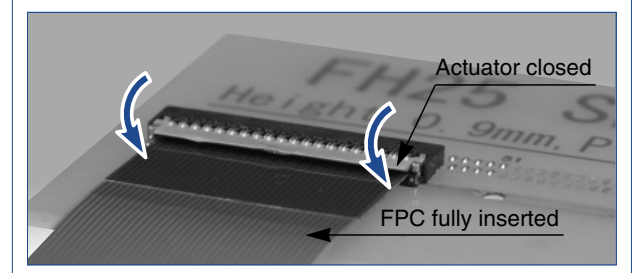
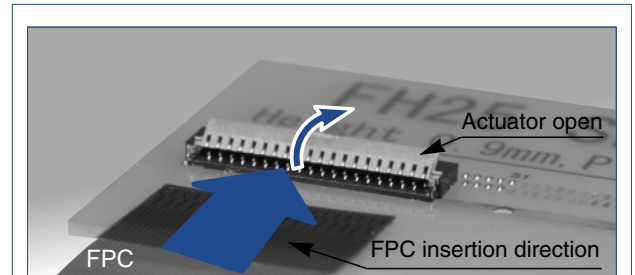
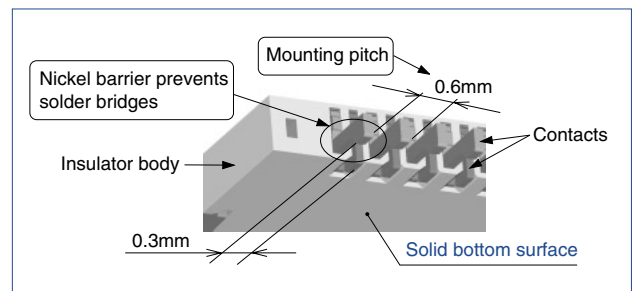
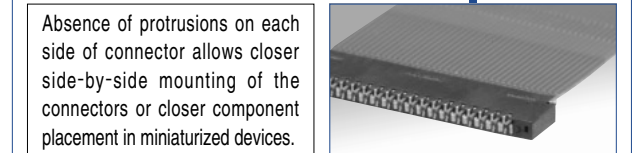
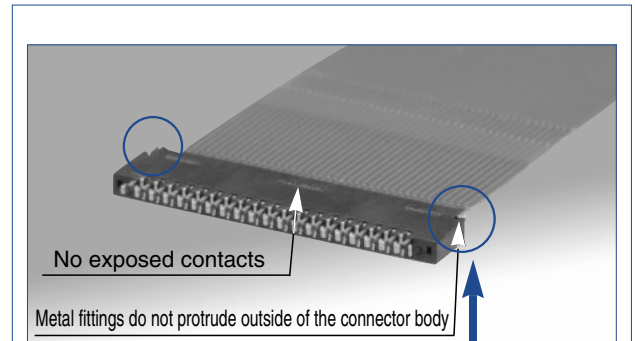
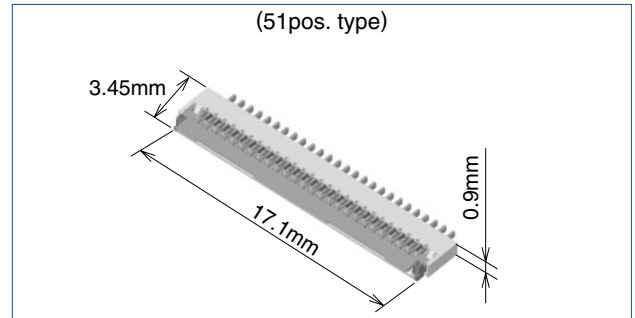

Product Specifications

Rating	Rated current 0.15 A DC Rated voltage 30 V AC	Operating temperature range -55°C to +85°C (Note 1) Operating humidity range Relative humidity 90% max. (No condensation)	Storage temperature range -10°C to +50°C (Note 2) Storage humidity range Relative humidity 90% max.
--------	--	--	--

Recommended FPC	Thickness: = 0.2±0.03mm thick, gold plated connecting traces
-----------------	--

Item	Specification	Conditions
1. Insulation resistance	50 M ohms min.	100 V DC
2. Withstanding voltage	No flashover or insulation breakdown.	90 V AC /one minute
3. Contact resistance	100 m ohms max. * Including FPC conductor resistance	1 mA
4. Durability (insertion/ withdrawal)	Contact resistance: 100 m ohms max. No damage, cracks, or parts dislocation.	10 cycles
5. Vibration	No electrical discontinuity of 1 μs or more. Contact resistance: 100 m ohms max. No damage, cracks, or parts dislocation.	Frequency: 10 to 55 Hz, single amplitude of 0.75 mm, 10 cycles,3 axis.
6. Shock	No electrical discontinuity of 1 μs. min. Contact resistance: 100 m ohms max. No damage, cracks, or parts dislocation.	Acceleration of 981 m/s ² , 6 ms duration, sine half-wave waveform, 3 cycles,3 axis.
7. Humidity (Steady state)	Contact resistance: 100 m ohms max. Insulation resistance: 50 M ohms min. No affect on appearance or performance.	96 hours at temperature of 40°C and humidity of 90% to 95%.
8. Temperature cycle	Contact resistance: 100 m ohms max. Insulation resistance: 50 M ohms min. No damage, cracks, or parts looseness.	Temperature: -55°C → +15°C to +35°C → +85°C → +15°C to +35°C Time: 30 → 2 to 3 → 30 → 2 to 3 (Minutes) 5 cycles
9. Resistance to soldering heat	No deformation of components affecting performance.	Reflow: At the recommended temperature profile Manual soldering: 350°C±5°C for 5 seconds

Note 1: Includes temperature rise caused by current flow.

Note 2: The term "storage" refers to products stored for long period of time prior to mounting and use. Operating Temperature Range and Humidity range covers non- conducting condition of installed connectors in storage, shipment or during transportation.

Materials

Part	Material	Finish	Remarks
Insulator	LCP	Color: Black	UL94V-0
	LCP	Color: Dark brown	
Contacts	Phosphor bronze	Gold plated	_____
Metal fittings	Phosphor bronze	Tin plated(No-lead)	_____

Ordering information

FH25- 51S - 0.3 - SH (05)

① ② ③ ④ ⑤

① Series name: FH25	④ Terminal type SH: SMT horizontal mounting type
② No. of contacts Number of contacts: 21, 27, 33, 39, 45, 51	
③ Contact pitch: 0.3 mm	⑤ Plating specifications (05): Gold, selective flash plated

◆ Operation and Precautions

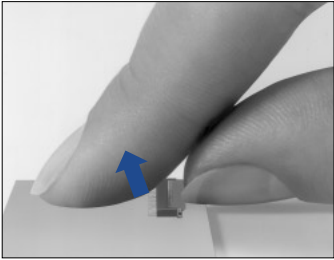
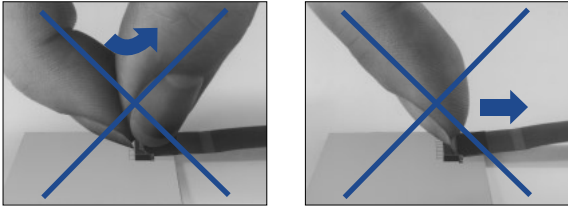
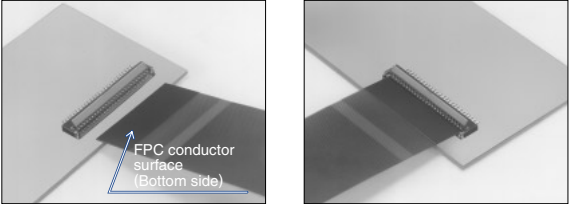
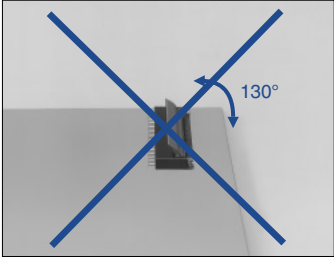
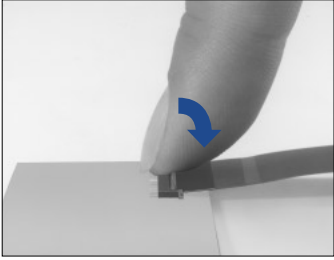
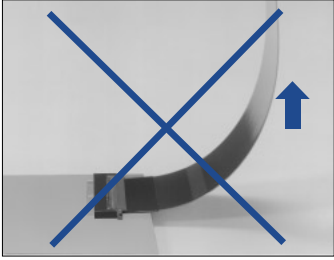
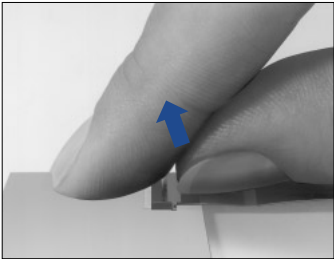
Operation	Precautions
<p>1.FPC insertion procedure. Connector installed on the board.</p> <p>① Lift up the actuator. Use thumb or index finger.</p> 	<p>① Do not apply excessive force or use any type of tool to operate the actuator.</p> 
<p>② Fully insert the FPC in the connector parallel to mounting surface, with the exposed conductor traces facing down.</p> 	<p>② The connector will assure reliable performance when the actuator is open to 130° maximum. Do not exceed this angle, as this may cause permanent damage to the connector.</p> 
<p>③ Rotate down the actuator until firmly closed. It is critical that the inserted FPC is not moved and remains fully inserted.</p> 	<p>③ Exercise caution when applying upward force to the connected FPC. FPC conductor surface on opposite side.</p> 
<p>2.FPC removal</p> <p>① Lift up the actuator. Carefully withdraw the FPC.</p> 	

◆ Packaging Specification

● Embossed Carrier Tape Dimensions

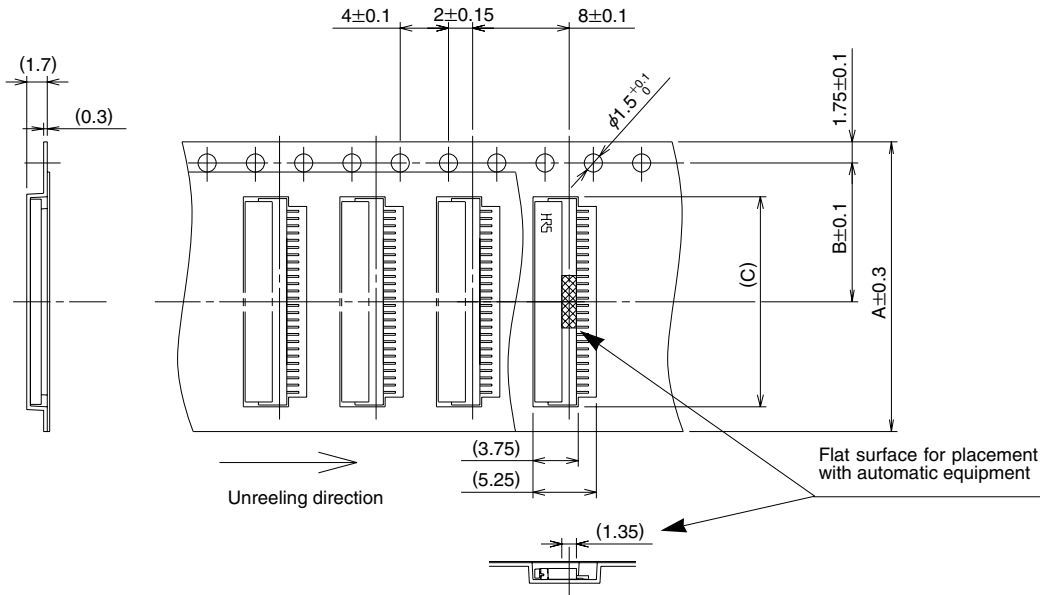

Unit: mm

Part Number	CL No.	Number of Contacts	A	B	C	D
FH25-21S-0.3SH(05)	CL586-1204-3-05	21	16	7.5	8.4	16.5
FH25-27S-0.3SH(05)	CL586-1205-6-05	27	24	11.5	10.2	24.5
FH25-33S-0.3SH(05)	CL586-1207-1-05	33	24	11.5	12.0	24.5
FH25-39S-0.3SH(05)	CL586-1208-4-05	39	24	11.5	13.8	24.5
FH25-45S-0.3SH(05)	CL586-1209-7-05	45	24	11.5	15.6	24.5
FH25-51S-0.3SH(05)	CL586-1200-2-05	51	24	11.5	17.4	24.5

5,000 pieces per reel.

● Reel Dimensions

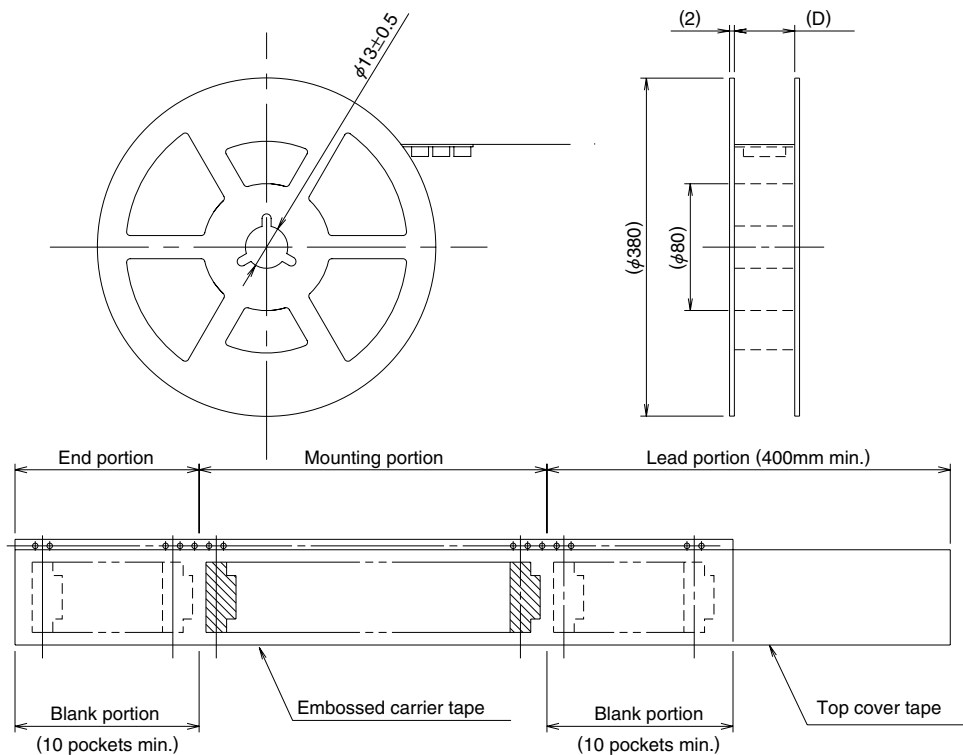

◆ Recommended Temperature Profile

● Using Typical Solder Paste

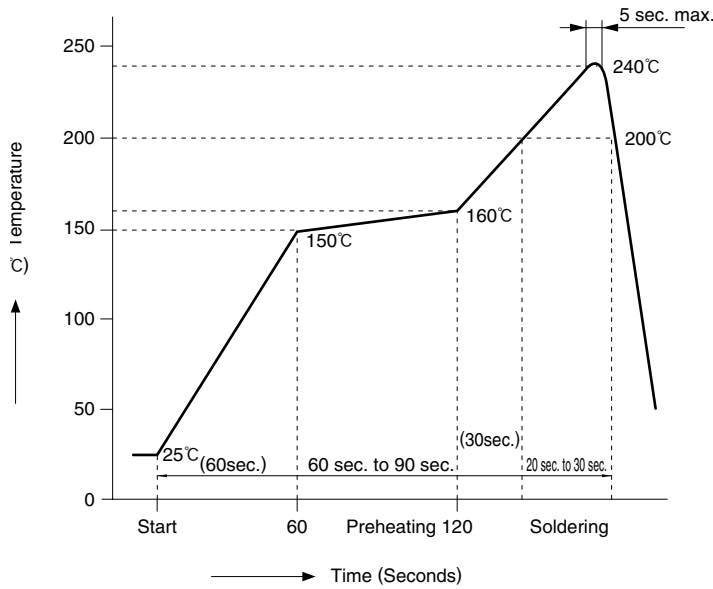

HRS test conditions

Solder method	:Reflow, IR/hot air (Nihon Den-nettsu Co., Ltd.'s Part Number: SENSBY NR-II)
Environment	:Room air
Solder composition	:Paste, 63%Sn/37%Pb (Senju Metal Industry, Co., Ltd.'s Part Number: OZ63-201C-50-9)
Test board	:Glass epoxy 70mm×80mm×1.6mm thick Land dimensions: 0.3mm×0.65mm, 0.3mm×0.8mm
Metal mask	:0.23×0.55×0.1mm thick, 0.23×0.65×0.1mm thick

● Using Lead-free Solder Paste

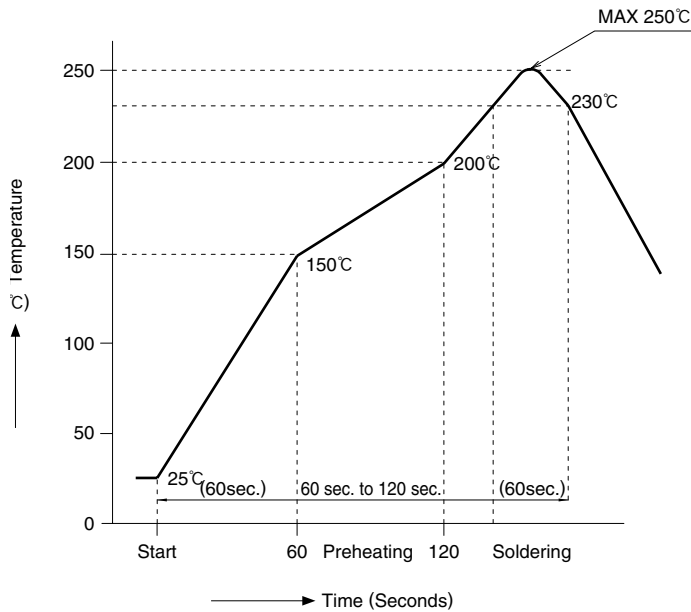

HRS test condition

Solder method	:Reflow, IR/hot air (Nihon Den-nettsu Co., Ltd.'s Part Number: SENSBY NR-II)
Environment	:Room air
Solder composition	:Paste, 96.5%Sn/3.0%Ag/0.5%Cu (Senju Metal Industry, Co., Ltd.'s Part Number: M705-221CM5-42-10.5)
Test board	:Glass epoxy 70mm×80mm×1.6mm thick Land dimensions: 0.3mm×0.65mm, 0.3mm×0.8mm
Metal mask	:0.23×0.55×0.1mm thick, 0.23×0.65×0.1mm thick

The temperature profiles are based on the above conditions.
 In individual applications the actual temperature may vary,
 depending on solder paste type, volume/thickness and board
 size/thickness. Consult your solder paste and equipment
 manufacturer for specific recommendations.

◆FH25 Series FPC Construction (Recommended)

1. Using Single-sided FPC

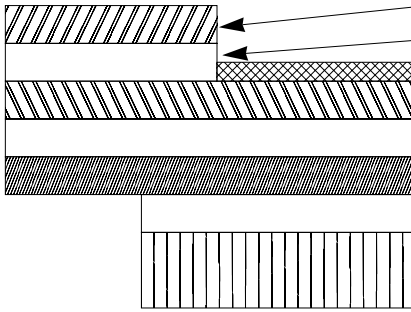

Name	Material	Thickness (μm)
Covering film layer	Polyamide 1 mil thick.	25
Cover adhesive		25
Surface treatment	1 μm to 5 μm nickel underplated 0.2 μm gold plated	(3)
Copper foil	Cu 1oz	35
Base adhesive		25
Base film	Polyamide 1 mil thick	25
Reinforcement material adhesive		30
Stiffener	Polyamide 3 mil thick	75
Total		193

2. Using Double-sided FPC

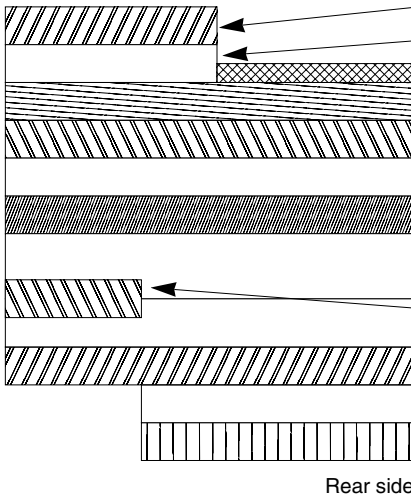

Name	Material	Thickness (μm)
Covering film layer	Polyamide 1 mil thick	25
Cover adhesive		25
Surface treatment	1 μm to 5 μm nickel underplated 0.2 μm gold plated	(3)
Through-hole copper	Cu	15
Copper foil	Cu 1/2oz	18
Base adhesive		18
Base film	Polyamide 1 mil thick	25
Base adhesive		18
Copper foil	Cu 1/2oz	18
Cover adhesive		25
Covering layer film	Polyamide 1 mil thick	25
Reinforcement material adhesive		25
Stiffener	Polyamide 1 mil thick	25
Total		197

To prevent release of the lock due to FPC bending, use of the FPC with copper foil on rear side is NOT RECOMMENDED.

3. Precautions

Note: Recommended specification for FPC 0.2 ± 0.03 mm thick.